

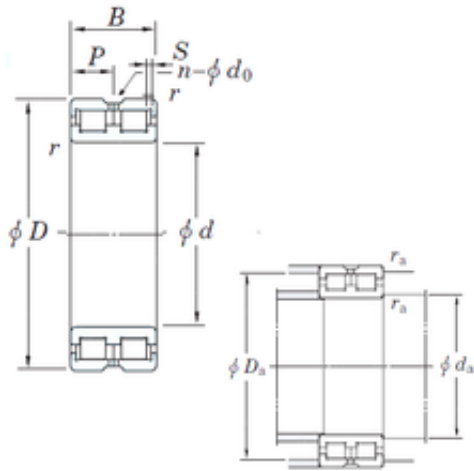

BEARING-THAILAND CO.,LTD



DC4868VW KOYO Full complement cylindrical roller bearings

Bearing No. DC4868VW

DC4868VW Bearing 2D drawings and 3D CAD models

Size	340x420x80 mm
Bore Diameter	340 mm
Outer Diameter	420 mm
Width	80 mm
d	340 mm
D	420 mm
B	80 mm
C	80 mm
n	8 mm
p	40 mm
r min.	2,1 mm
S	6 mm
da min.	352 mm
Da max.	408 mm
ra max.	2 mm
Weight	25,6 Kg
Basic dynamic load rating (C)	853 kN
Bearing No.	DC4868VW
r(min)	2.1
Cr	853
C0r	2430
S	6 mm
P	40
n(qty)	8
do	6



BEARING-THAILAND CO.,LTD

da(min)	352
Da(max)	408
ra(max)	2
(Refer.)Mass(Fixed side)(kg)	24.8